



Avions Fairey Topsy S2

An electric version of the '30s classic

Scale and unique airplanes always appeal to me, and when I first saw an article on the full-size Topsy S2, I knew I needed to model it. I used 3-view drawing from the article to develop my 1/6-scale plans. The Topsy airplane line was designed by Belgium designer Ernest Tips. The S2 was designed and built back in the mid-1930s and was powered with a variety of small 2- and 4-cylinder engines. After doing some research, I found aircraft "00-TIP" in a Belgium Airplane Museum; it was powered by a 2-cylinder 28 HP Douglas Sprite engine. I loved the "Spitfire" looks with elliptical surfaces and also the attractive red, white and black color scheme. I also discovered a great book all about Ernest Tips designs, "Les Avions Topsy Airplanes" by Vincent Jacobs. I ordered the book direct from the author in Belgium.

GETTING STARTED

The construction is all balsa with a fully sheeted wing. The tail surfaces are built up and use laminated construction for the outlines of the fin, rudder, stab, and elevators. The airplane has a fairly short nose, so try and keep the tail feathers as light as possible. The engine and stabilizer are set to 0 degrees and the wing has +2 degrees of incidence.

TAIL GROUP

Using foam board, make templates for the rudder, fin, stab, and elevators to form the laminations. The laminations are three pieces of

3/16 x 1/16-inch balsa soaked in warm water for 20 minutes. Glue the laminations together with Titebond glue. When they've fully dried, place them over the plans and add the balsa sticks and other pieces noted on the plans. Note the grain direction on the S1 piece. Because of the unique design of the stabilizer and elevators you will need to use two separate elevator pushrods.

FUSELAGE

Build the fuselage box, from F1 to the tail first, then add the firewall and balsa nose pieces. Cut formers F1 and F2 from 1/8-inch plywood along with the balsa wing saddle and the balsa stabilizer doubler. Build the two fuselage sides over the plans, then glue F1 and F2 to one side of the fuselage. Now join the sides upside-down over the plans' top view, making sure everything is lined up with the centerline. Sand the inside of tail post (on both sides) before gluing together to produce a 3/16-inch thick tail post. Add the balsa crosspieces at the F3, F4, and F5 positions using the top view to get the correct crosspiece lengths. This will be more important once the turtledeck formers are in place, as the turtledeck sheeting will be flush with the square longerons. Cut to shape your plywood firewall and the two pieces of balsa that form the front of the fuselage. Shim the upside-down fuselage up off your building board with some scrap wood. This allows you to glue the front side balsa pieces and to align the

SPECIFICATIONS

Model: Topsy S2
Wingspan: 50 in.
Length: 36 in.
Weight: 2 lb., 8 oz.
Wing area: 382 sq. in.
Wing Loading: 15.5 oz./sq. ft.
Power req'd: 480 class outrunner
Radio req'd: 4-channel (rudder, throttle, ailerons and elevator)

GEAR USED

Radio: Spektrum DXB w AR6200 receiver (spektrumrc.com) and 4 JR NES241 servos (jramerica.com)
Motor: Scorpion 3008-32 (innov8tivedesigns.com) w/ Castle Creations Thunderbird 36 speed control (castlecreations.com)
Battery: Glacier 3S 2600mAh (buddyrc.com)
Prop: APC 10 x 5E (landingproducts.com)

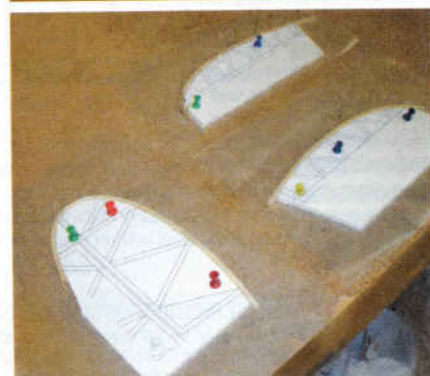

To make the laminations for the tail surfaces, make the forms from foam board. Here the formed parts are shown ready to be removed.

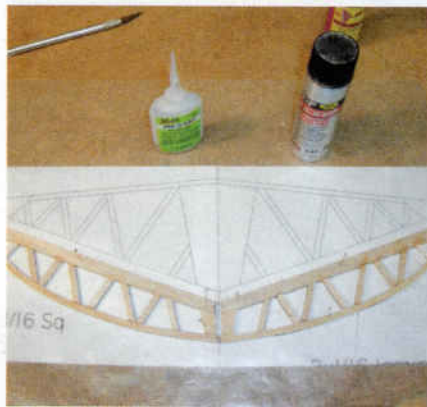

Here the elevators are ready to remove from the boards.

firewall at 90 degrees with the workbench.

The cowl is held in place with magnets and keyed with 1/8-inch dowels. Add the balsa triangle stock to the top of the front balsa sides then add the balsa block to form the top of the fuselage from the firewall back to F1A. Glue formers F2A, F3, F4 and F5 to the top of the fuselage keeping them square to the top of the fuselage. Add the square balsa stringer and sheet the turtle deck with 1/16 inch balsa. Next cut out the hatch parts and floor along with H1, H2, H3, and H4. Assemble in place on the fuselage to get a good alignment. The hatch is held in place with eight magnets. Add balsa gussets on the inside corners of the fuselage along with the inside floor of the hatch. I pinned my hatch to a piece of flat 1/4-inch balsa and planked the hatch with 3/32-inch balsa.

Attach the motor and build up the removable cowl using the plans as a guide and cut the sides, top, and bottom balsa blocks. Attach the 1.5-inch spinner, position the hatch in place and shape the front of the cowl and the fuselage. The engine cylinders are made from 1/16 balsa



The designer and author is a happy pilot after the first flight!

discs assembled on 1/8 dowels that I shaped with the cylinders chucked into my cordless drill and some sanding blocks. Add the rocker cover and pushrod details and glue in place after the fuselage is covered. Leave the forward balsa sheeting off until the wing is attached, this allows you to drill the hole in the wing for the alignment dowel.

WING

The wing is fully sheeted, so you'll need to make

up four wing skins and cut out all the ribs. Also cut R2A and R3A from 1/8-inch plywood to strengthen the ribs where the landing gear hardwood blocks are installed. Pin the bottom spar to the bottom sheeting then place the ribs and the aft spar in position. Use the R1 dihedral template tool (shown on the plans) to set the root rib angle to provide a total wing dihedral of 4 degrees. I used a piece of tapered balsa to build in the washout in the outboard section of the wing. Place the lite plywood aileron servo

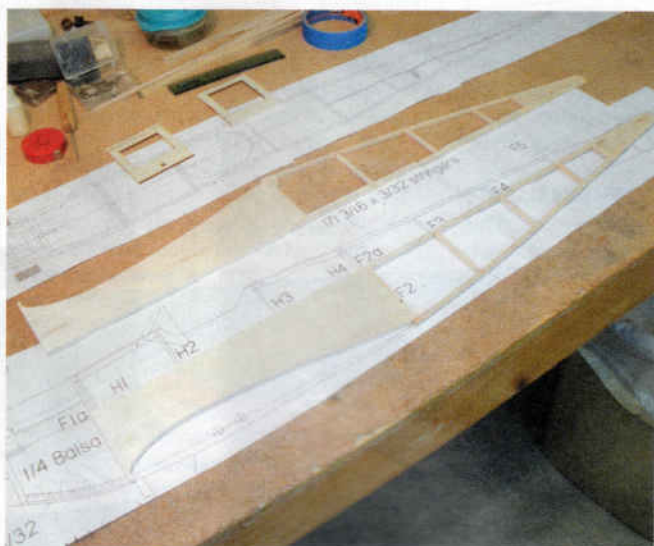

Here are the two fuselage side frames finished and ready to assemble together.



The basic top hatch cover is shown here ready to be planked with balsa strips.

HOME BUILT AVIONS FAIREY TIPSY S2

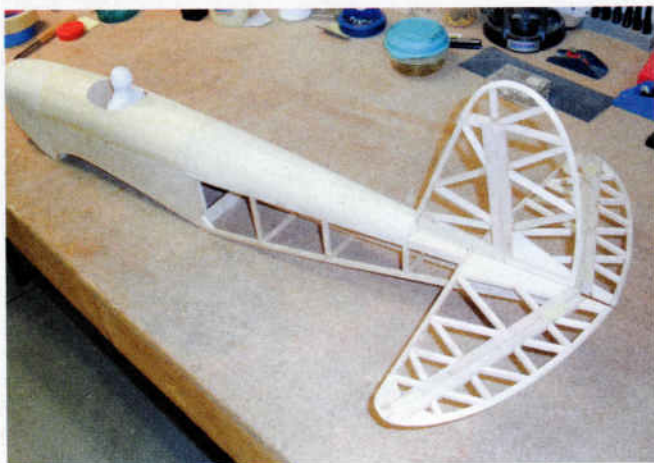

Fuselage and tail surfaces assembled together to check alignment.

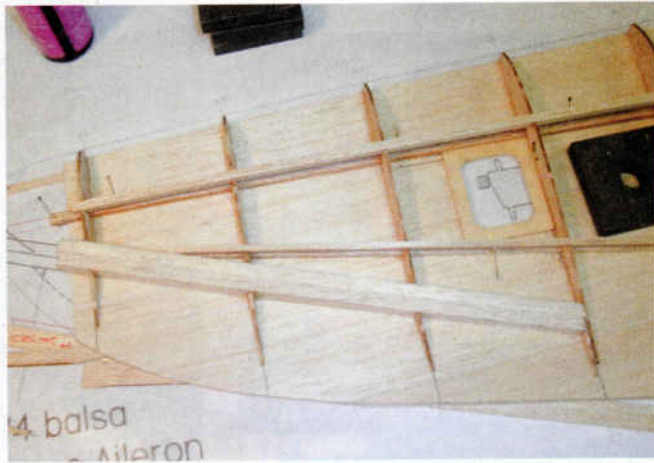

Basic wing assembly is shown here. Notice the aileron servo mount detail.

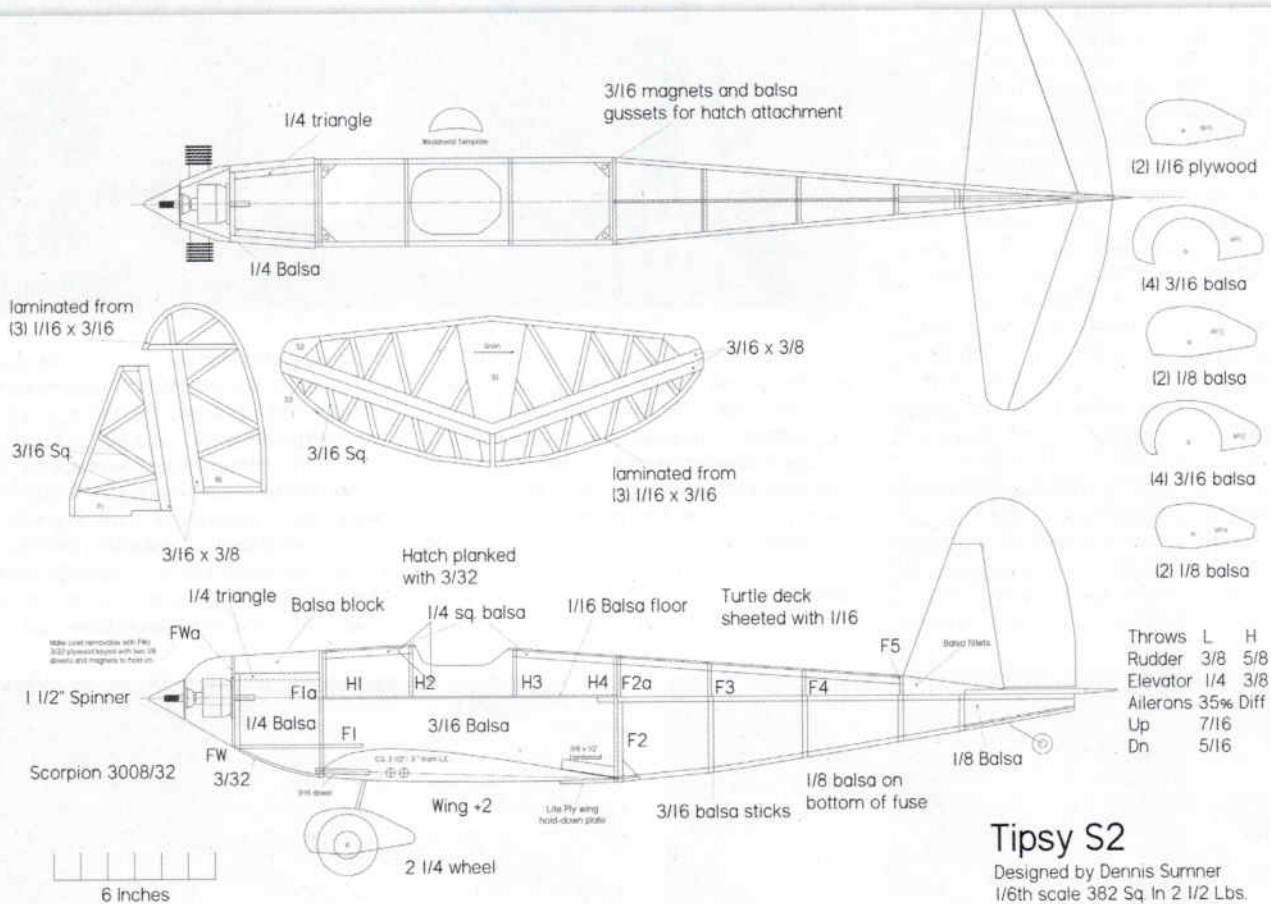

Topsy S2

Designed by Dennis Sumner
1/6th scale 382 Sq. In 2 1/2 Lbs.

Topsy S2 | K0715A

Designed by Dennis Sumner, the Topsy S2 is a great-flying sport-scale design using traditional balsa and ply construction and a modern electric power system. It features an elliptical wing and tail surface design and uses magnets to hold the engine cowl and hatch cover in place. Its light wing loading makes this a great flying airplane and it would make a great first scale project. **WS:** 50 in.; **length:** 36 in.; **radio:** 4-channel; **power:** electric 480 class outrunner; **LD:** 2; **2 sheets;** \$23.95



To order the full-size plan, visit AirAgeStore.com



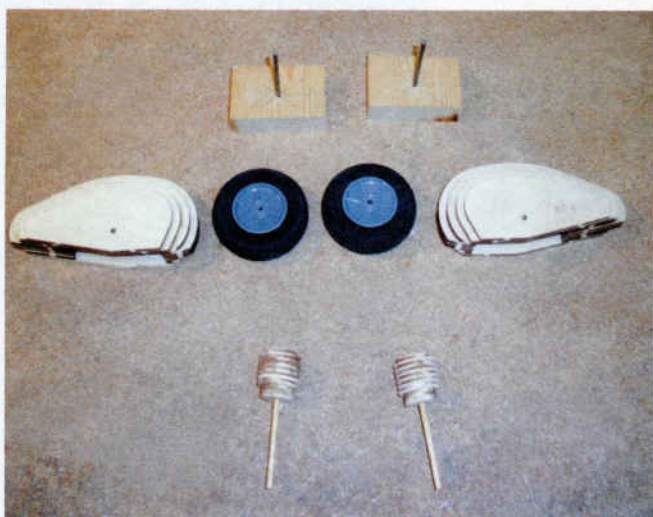

Basic parts for the wheel pants and the dummy engine cylinders are shown here.



The basic airframe all assembled to check everything's fit and alignment.

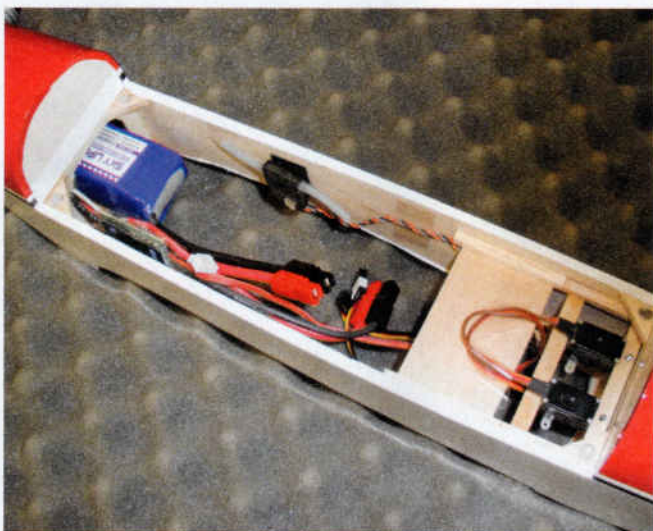

With the main hatch cover removed, you have access to the radio compartment.



Pilot figure and basic cockpit details add a lot to the model's scale appearance.

mount/frame between ribs R6 and R7. Trace around the mount then center the aileron plate/hatch and cut the skin out before gluing the 1/8 mounting plate. Framing the ailerons is the only tricky part of the wing. Start by marking the location of the two 1/4-inch pieces on the sheeting. They will frame the ailerons. Don't glue these pieces together as this will be the aileron hinge line. With the lines marked you can cut a half inch section out of the ribs for the pieces. Once the ribs are glued to the bottom sheeting, sand the balsa pieces to match the ribs. (Use pins to mark the hinge line through the bottom skin and inside edge of the ailerons). Also use pins to mark the corners for the hardwood landing gear blocks.

Glue the top main and aft spars in place and add the shear webs to the main spars. Add pull strings for the aileron servos before gluing the top skins in place. When the glue has dried, sand the skins flush with the ribs' leading edges and glue the balsa leading edges

in place. Shape the leading edges and then cut the ailerons free. Add the balsa tips and hinge the ailerons in place. Glue the panels together and glass the joint with three layers of 0.75-ounce fiberglass using 1-, 2- and 3-inch wide strips.

FINAL ASSEMBLY AND FINISHING

Before bolting on the wing in place, make sure the stabilizer and motor are set to 0 degrees and the wing sets at 2 degrees positive. Drill the hole in the wing leading edge for the dowel then add the bottom fuselage sheeting. Glue the stabilizer and fin in place, add a steerable tail wheel or a skid. Once the stabilizer and fin are glued in place, add the balsa stabilizer fillets. Cut out the parts for the wheel pants and assemble on 1/8-inch music wire, then cut and sand to shape. Install the rudder and elevator servos in front of former F2. Fabricate and glue in place the battery tray.

For covering my prototype, I used white

UltraCote and True Red MonoKote. Glue the engine cylinders in place and add a pilot and windscreen. My 00-TIP graphics are from Callie's Graphics.

IN THE AIR

Make sure you balance the model as shown on the plans. With a Scorpion 3008-32, 3S 2600mAh LiPo and an APC 10x5E prop I am getting 100 watts of input power. It requires a touch of right rudder on the takeoff roll and with its light wing loading, the Topsy flies very well. Early on I was concerned about tip-stalling due to the elliptical wing tips but with built-in wing washout and 35% of aileron differential, the model really doesn't have any bad habits.

Try some stalls at altitude to get a feel for it then bring it in for your first landing. It does some nice aerobatics with loops, rolls, and Cuban-8s. I think you will be pleased with its looks and performance. ✈